

3  
2  
1

ZONE REV. DESCRIPTION APPROVAL DATE

RoHS  
Compliant

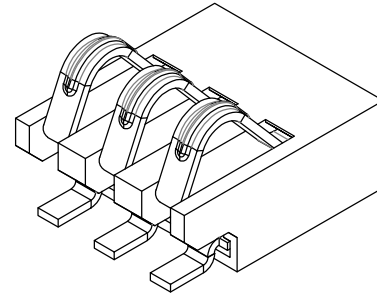

性能:

额定电流: 1.0A  
 额定电压: 12V  
 耐电压: 500V  
 接触电阻: 30mΩ MAX  
 绝缘电阻: 500MΩ  
 工作温度: -40℃~+85℃  
 塑件(材质): LCP E130I  
 接触点(材质): 铜合金, 触点镀金3u''

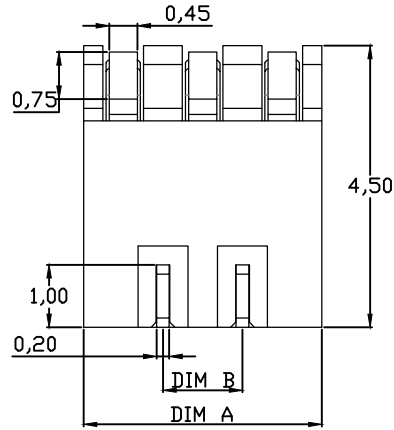
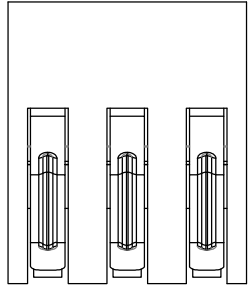

PART NO.	DIM A	DIM B
KH-12701-2P225		2.54
KH-12701-3P225		3.81
KH-12701-4P225	5.08	2.54
KH-12701-5P225	6.35	3.81
KH-12701-6P225	7.62	5.08

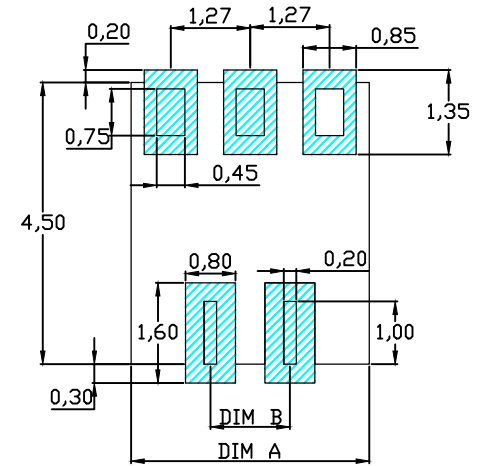
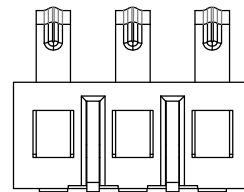
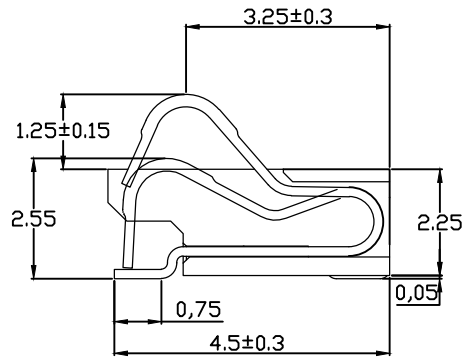
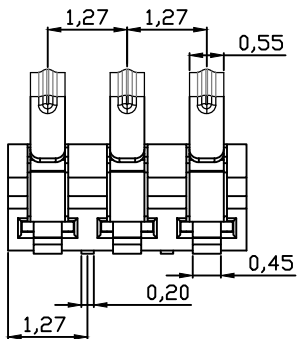

RECOMMENDED PCB LAYOUT  
 TOP VIEW (. XX ± 0.05)

深圳市金航标电子有限公司

www.kinghelm.com.cn

DESIGN X. Z. Huang

SCALE



TOLERANCE

PART NAME

电池座

KH-12701-3P225

0755-28190160

DRAWING X. Z. Huang

UNIT mm



X. ±0.35

PART NO.

KH-12701系列

CHECK X. X. Zheng

SIZE

A4:210:297

X. X ±0.25

DWG. NO.

RBD-SP-0019

APPROVAL M. Y. Li

VER.

01

ANGLE ±3°

DATE

2019-11-04

1

2

3

4

5

6