

SPECIFICATIONS

- 1、Current Rating: 3A AC, DC
- 2、Voltage Rating: 250V AC, DC
- 3、Temperatuer Range: -25°C~+85°C
- 4、Contact Resistance: 30mΩ Max
- 5、Insulation Resistance: 1000MΩ Min
- 6、Withstanding Voltang: 800V AC/minute
- 7、Material: Wafer PA66, Beige UL94V-0
PIN Brass Tin-plated

版本 REV.	日期 DATE	ECN NO.	变更内容 DESCRIPTION	制图 DRAWN

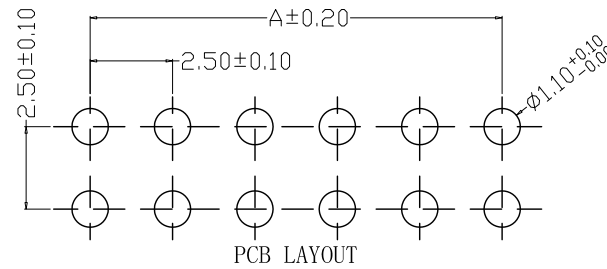
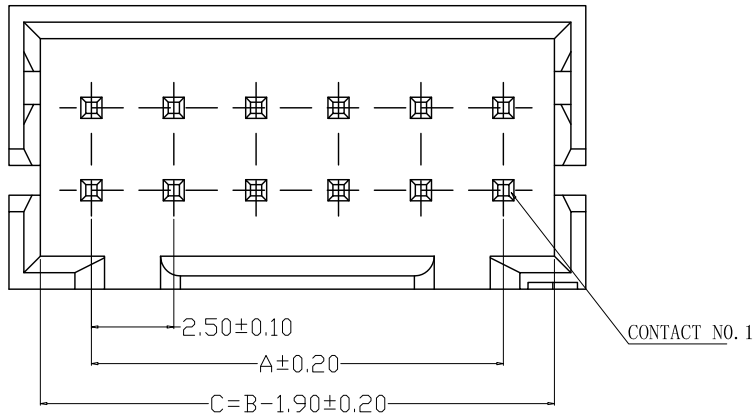
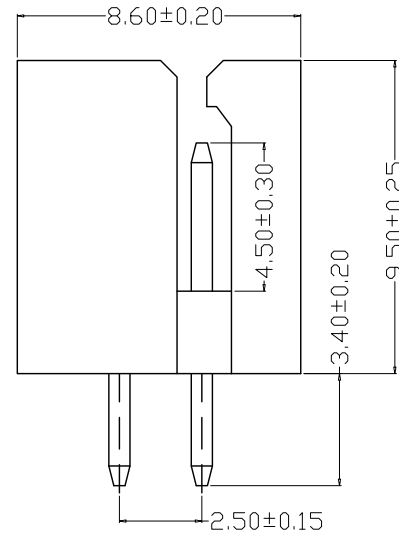
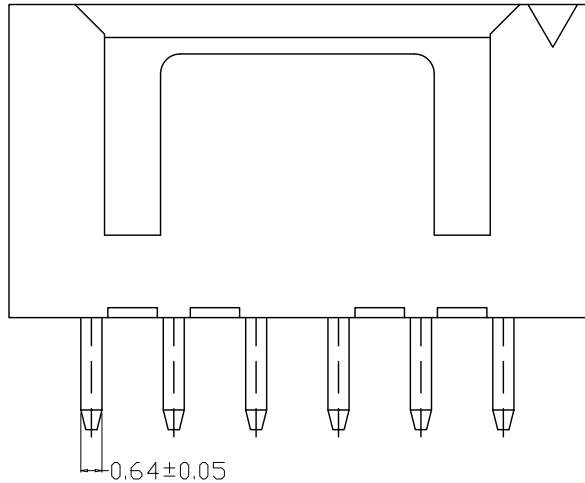
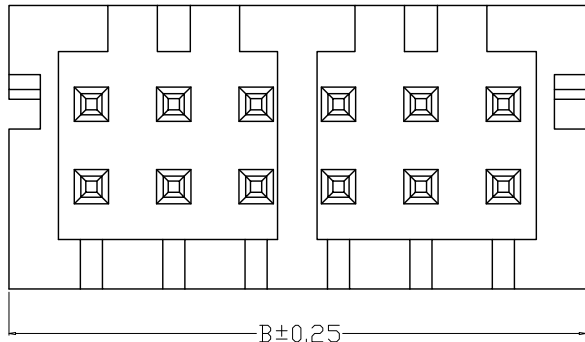
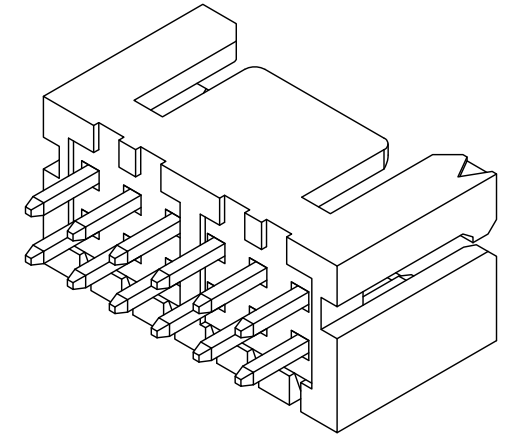

编 号	尺寸 (mm)	
	A	B
A2557-2*02A	2.50	7.50
A2557-2*03A	5.00	10.00
A2557-2*04A	7.50	12.50
A2557-2*05A	10.00	15.00
A2557-2*06A	12.50	17.50
A2557-2*07A	15.00	20.00
A2557-2*08A	17.50	22.50
A2557-2*09A	20.00	25.00
A2557-2*10A	22.50	27.50
A2557-2*11A	25.00	30.00
A2557-2*12A	27.50	32.50
A2557-2*20A	47.50	52.50

GENERAL TOLERANCE		制图	钱岳生		料号	A2557-2*02nA		版本	A
X.X±0.25	X.*±2'	DRAWING	2021、05、03		PART NO.	XHD2.5直针		页次	1/1
X.XX±0.20		审核	张名		TITLE	WAFER DIP TYPE		SHEET	
X.XXX±0.10		CHECK	2021、05、04		客户料号				
		核 准	张名		CUTM. NO.				
		APPROVAL	2021、05、05		深圳市金航标电子有限公司		www.kinghelm.com.cn		
		单 位	MM	比 例	1:1	KH-A2557-2X05A		0755-28190160	
		UNITS		SCALE					